

Controller Indicator Transmitter 1/32 DIN - 48 x 24 mm gamma**due**[®] series C1 line

Small, easy and comprehensive

Easy configuration and simple operating method. The smallest line of the gamma**due**[®] series concentrates the functionality of the temperature controller-indicator-transmitter without losing the typical characteristics of more complex devices like: autotune, IP65 front panel protection, serial communications,

analogue retransmission output, custom linearisation, and transmitter power supply.

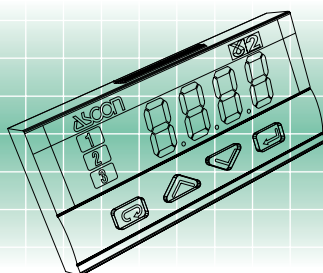
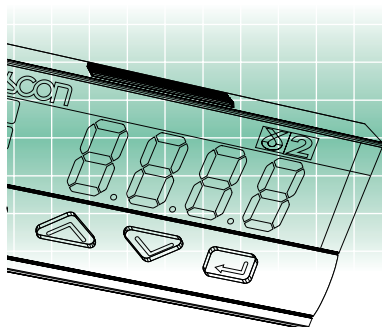
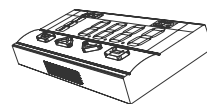

E

ISO 9001 Certified

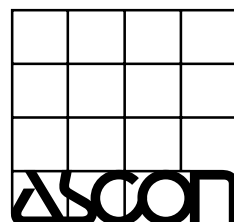

ASCON spa

20021 Bollate - (Milano) Italy - Via Falzarego, 9/11 - Tel. +39 02 333 371 - Fax +39 02 350 4243

<http://www.ascon.it> e-mail info@ascon.it



gammadue[®]

the right solution to your needs

Your needs	Our solutions
Restricted space and reduction of the instrumentation overall dimensions	1/32 DIN - 48 x 24 Size
Easy replacement and quick start-up	Configuration by simple to use codes
Correct tuning for any condition	Automatic selection between two different methods
Conversion and retransmission of low level signals	Transmitter with isolated and analogue output
Contactless temperature measurements	Indicator with infrared input ability
Alarm signalling	Absolute and deviation alarms
Interfacing with other devices	Serial communications at 9600 baud Modbus/Jbus protocol, analogue retransmission output
Quick learning	Every model has the same operating method
Ergonomic compatibility with other devices	Two colours: beige or darkgrey front panels
Environmental protection	IP65 front panel protection (indoor, dust and water protection)
Easy to use	Ergonomic keypad, clear and comprehensive display
Noise immunity	Electromagnetic compatibility
Universal input signals, linear as well as non-linear	Configurable input (TC, RTD, mA, Volt and ΔT , infrared sensor, custom linearisation)
Reliability and safety	CE compatibility, ASCON is ISO 9001 certified, 3 years warranty
Technical support	Technical application assistance from ASCON sales and after sales service

Resources Operating mode

Main universal input

5 TC Pt100 ΔT mA V Custom PV

Setpoint

LOC

Operating mode

	Control	Alarms	Retransmission
0	Indication only	OP1 OP2	PV OP4
1	Single action	OP1	OP2 OP4
2	Single action	OP2	OP1 OP4

C1

OP1

OP2

OP4 (option)

Modbus RS485
Parameterisation
Supervision
(option)

Fuzzy tuning with automatic selection

One shot Auto tuning One shot Natural Frequency

Technical data

Features at env. 25°C	Description			
Total configurability	From keypad or serial communications, the user selects:			
	<ul style="list-style-type: none"> - the type of input - the associated functions and the corresponding outputs - the type of control algorithm - the type of output and the safe conditions - the type and functionality of the alarms - the values of all the control parameters 			
PV input (for signal ranges see table 1)	Common characteristics	A/D converter with 50.000 points Update measurement time : 0.2 sec Sampling time : 0.5 sec Input shift : ± 60 digits Input filter : 1...30 sec (OFF= 0)		
	Accuracy	0.25% ± 1 digit (T/C and RTD) 0.1% ± 1 digit (mA and mV)	Between 100 and 240V - error is minimal	
	Resistance thermometer (for ΔT: R1+R2 must be <320Ω)	PT100Ω at 0°C (IEC 751) °C /°F selectable	2 or 3 wire connection	Line: 20Ω max (3 wire) Thermal drift 0.1°C/10°C env. T. <0.1°C/10Ω line resist.
	Thermocouple	L, J, T, K, S (IEC 584) °C /°F selectable	Internal cold junction compensation	Line: 150Ω max Thermal drift <2μV/°C env. T. <0.5μV/10° line resist.
	DC input (current)	0/4...20mA with 2.5Ω ext. Shunt Rj > 10MΩ	Engineering units, floating decimal point, Low Range -999...9999	Input drift: < 0.1%/20°C env. T.
	DC input (voltage)	0/10...50mV Rj > 10MΩ	High Range -999...9999 100 digits minimum	
	Operating modes	Indicator with 2 alarms	AL1 alarm	AL2 alarm
OP1- relay or triac			OP2 - SSR drive	
OP2 - SSR drive			OP1 - relay or triac	
1 PID loop or ON/OFF with 1 alarm		Control output	AL2 alarm	OP2 - SSR drive
Control mode	Algorithm	P.I.D. with overshoot control or ON/OFF		
	Proport. band (P)	0.5...999.9%		
	Integral time (I)	0.1...100.0 min.	OFF = 0	P.I.D. algorithm
	Derivative time (D)	0.01...10.00 min.		
	Cycle time	1...200 sec.s		
	Overshoot control	0.01...1.00		
	High limit	100.0...10.0%		
Hysteresis	0.1...10.0%			
			ON/OFF algorithm	
OP1 output	SPST relay N.O., 2A/250V (for resistive load) Triac, 2A/250V- for contactor coil			
OP2 output	SSR drive not isolated: 5V-, ± 10%, 30mA max			
AL1 alarm (indicator with 2 alarms)	Hysteresis 0.1...10.0% range			
	Active high	Absolute threshold, whole range		
	Active low			
AL2 alarm	Hysteresis 0.1...10.0% range			
	Action	Active high	Action type	Deviation threshold ± range
		Active low		Band threshold 0...range
		Special function	Sensor break	Absolute threshold, whole range
Setpoint	Up and down ramps		0.1...999.9 digit/min (OFF = 0)	
	Low limit	from low range to high limit		
	High limit	from low limit to high range		
OP4 (option)	Galvanically isolated: 500V~/1min			
PV retransmission output	Resolution: 12bit (0.025%) Accuracy: 0.1%	Current output: 0/4...20mA 750Ω/15V max		
One-shot Fuzzy-Tuning	Depending on the process condition, the controller applies the best method		Step response Natural frequency	
Ser. comm.s (opt.)	RS 485 isolated, Modbus/Jbus protocol 1200, 2400, 4800, 9600 bit/sec, two wires			
Aux. p. supply	+18V- ±20%, 30mA max for external transmitter supply			

Input type	Scale range	
RTD Pt100Ω at 0°C	-99.9...300.0	°C
	-99.9...572.0	°F
	-200...600	°C
	-328...1112	°F
T/C type L Fe-Const.	0...600	°C
	32...1112	°F
T/C type J Fe-Cu 45% Ni	0...600	°C
	32...1112	°F
T/C type T Cu - CuNi	-200...400	°C
	-328...752	°F
T/C type K Cromel Alumel	0...1200	°C
	32...2192	°F
T/C type S Pt10%Rh-Pt	0...1600	°C
	32...2912	°F
0/4...20 mA	Configurable engineering units	
0/10...50 mV	mA, mV, V, bar, psi, Rh, ph	
mV Custom scale	On request	

Table 1 : PV input

Fuzzy Tuning

Two methods of tuning are available:

- **Auto-Tuning "one shot"**
- **Natural frequency "one shot"**

The **Fuzzy-Tuning** automatically selects one of the two methods which assure the best result for each condition.

The **Auto-Tuning** method works best on the step response basis.

When activated, if a deviation exists between the Setpoint and process variable larger than 5% of scale range, the controller modifies the output value. Then, in a short time, it calculates the PID parameters and the new algorithm is operational immediately.

The main advantages of this method are fast calculation and quick implementation.

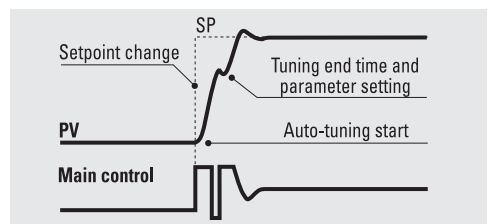

The **Natural frequency** method works best when the process variable is very near to the Setpoint. When activated, it causes a process oscillation around the Setpoint value.

The main advantage of this method is a reduced disturbance to the process.

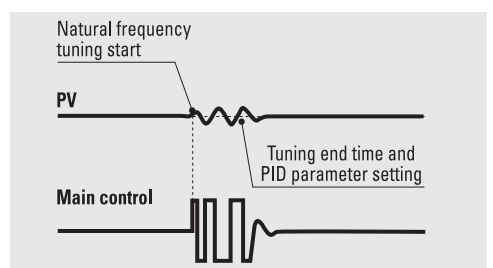

Technical data

Features at env. 25°C	Description	
Operational safety	Measure input	Detection of out of range, short circuit or sensor break with automatic activation of the safety strategies and alerts on display
	Control output	Safety value: 0...100%. (user enabled/disabled)
	Parameters	A non volatile memory stores for unlimited time all the parameter and configuration values
	Password	A password protects the access to the instrument configuration
General characteristics	Power supply	100-240V~ (-15% +10%) 50/60Hz or 24V~(-25% +12%), 50/60Hz and 24V- (-15% +25%). Power consumption 1.6W max
	Safety	Compliance EN61010-1 (IEC 1010-1), installation class 2 (2500V), pollution class 2, class II instrument
	Electromagnetic compatibility	Compliance to the CE standards for industrial system and equipment
	Protection EN60529 (IEC 529)	IP65 front panel
	Overall dimensions	$1/32$ DIN - 48 x 24, depth 120 mm, weight 100g appr. Panel cut-out: $45^{+0.6} \times 22.2^{+0.3}$ mm

Electrical wirings

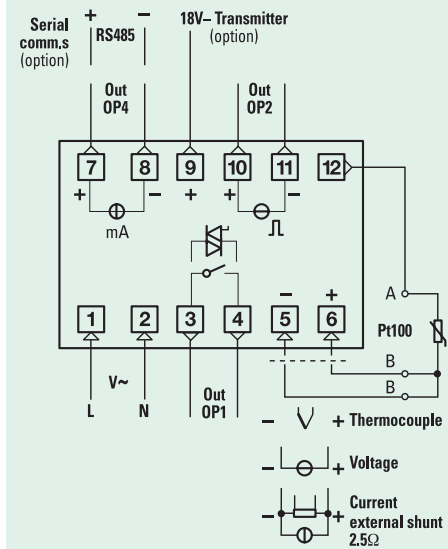

Ordering codes

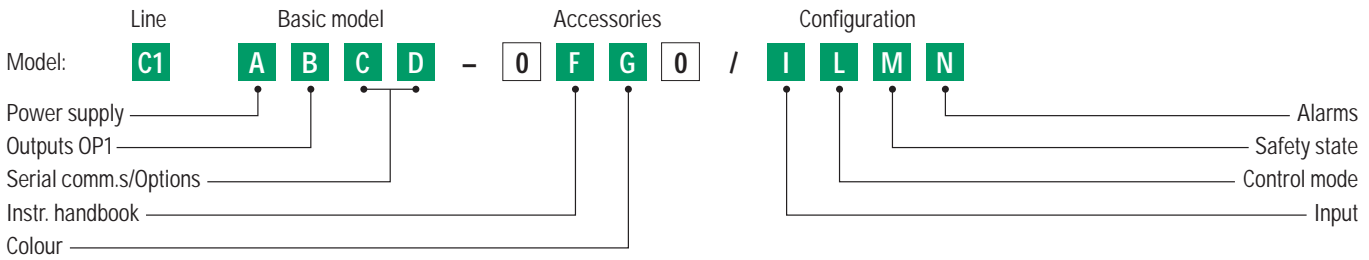

Power supply	A
100-240V~ (-15% +10%)	3
24V~ (-25% +12%) or 24V- (-15% +25%)	5

OP1 output	B
Relay	0
Triac	3

Serial comm.s	Options	C	D
Not fitted	None	0	0
	Transmitter power supply	0	6
	Transmitter power supply + Retransmission	0	7
RS485 Modbus/JBus protocol	None	5	0
	Transmitter power supply	5	6

Instruction handbook	F
Italian-English (std)	0
French-English	1
German-English	2
Spanish-English	3

Front case colour	G
Dark (std)	0
Beige	1

Input type	Range scale	I
RTD Pt100 IEC751	-99.9...300.0 °C -99.9...572.0 °F	0
RTD Pt100 IEC751	-200...600 °C -328...1112 °F	1
TC L Fe-Const DIN43710	0...600 °C 32...1112 °F	2
TC J Fe-Cu45% Ni IEC584	0...600 °C 32...1112 °F	3
TC T Cu-CuNi	-200...400 °C -328...752 °F	4
TC K Chromel -Alumel IEC584	0...1200 °C 32...2192 °F	5
TC S Pt10%Rh-Pt IEC584	0...1600 °C 32...2912 °F	6
0...50mV linear	Engineering units	7
10...50mV linear	Engineering units	8
mV "Custom" scale	On request	9

Output configuration	L
P.I.D. control OP1 / alarm AL2 on OP2	0
P.I.D. control OP2 / alarm AL2 on OP1	1
On - Off control OP1 / alarm AL2 on OP2	2
On - Off control OP2 / alarm AL2 on OP1	3
Indicator alarm AL1 on OP1 / alarm AL2 on OP2	4
Indicator with 2 alarms alarm AL1 on OP2 / alarm AL2 on OP1	5

Type of control	Safety	M
Reverse (AL1 active low)	0%	0
Direct (AL1 active high)	0%	1
Reverse (AL1 active low)	100%	2
Direct (AL1 active high)	100%	3

AL2 type and function	N
Disabled	0
Sensor break	1
Absolute active high	2
Absolute active low	3
Deviation active high	4
Deviation active low	5
Band active out	6
Band active in	7

If not differently specified the controller will be supplied with standard version
Model: C1 3000-0000

